

One Way Shut-Off 

INTERCHANGEABLE CEJN 320



74 SCFM 

 **Type H-1**

### Applications

- For construction work, mechanic, paint and body shops
- Offers a higher flow for maximum performance

### Features

- High impact resistance
- Interchangeable CEJN 320
- Very high flow performance
- Fully automatic
- High quality connection for heavy duty use
- Safety lip prevents accidental disconnection when dragged on the floor

### Specifications

**Maximum Working Pressure**  
500 PSI

**Working Temperature**  
-30°C to 100°C (-22°F to 212°F)

**Air Flow**  
74 SCFM

**Construction**  
Body : Nickel Plated Brass  
Locking Sleeve : Hardened Steel  
Seals : Nitrile  
Locking Balls and Springs : Stainless Steel

**AUTOMATIC  
COUPLER  
(BRASS)**

**PLUG  
(STEEL)**

### FEMALE THREAD

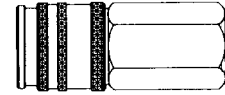
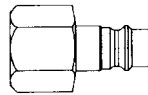

	Part No.	Part No.
1/8" (F) NPT	23.1122	-
1/4" (F) NPT	23.1142	23.1442
3/8" (F) NPT	23.1162	23.1462
1/2" (F) NPT	23.1172	23.1472

### MALE THREAD

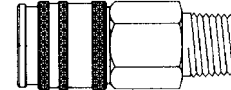
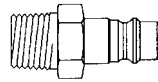

	Part No.	Part No.
1/8" (M) NPT	23.1222	-
1/4" (M) NPT	23.1242	23.1542
3/8" (M) NPT	23.1262	23.1562
1/2" (M) NPT	23.1272	23.1572

### HOSE BARB

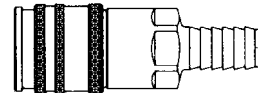
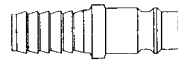

	Part No.	Part No.
1/4" I.D.	23.1342	23.1642
5/16" I.D.	23.1352	23.1652
3/8" I.D.	23.1362	23.1662
1/2" I.D.	23.1372	23.1672

### ANTI-HOSE WHIP NIPPLE

#### HOSE BARB

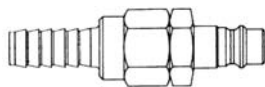

	Part No.
5/16" I.D.	23.1952
3/8" I.D.	23.1962
1/2" I.D.	23.1972

### Applications

- For applications requiring maximum safety

### Features

- Special design that prevents against hose whips by exhausting air slowly when disconnecting
- Slow purge valve

### PREVENTS DANGEROUS HOSE WHIPS

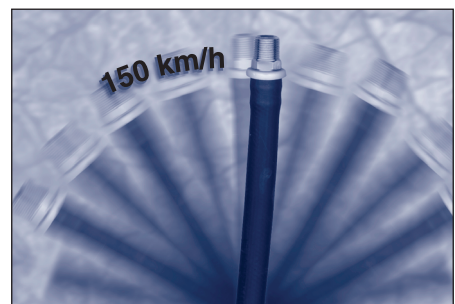

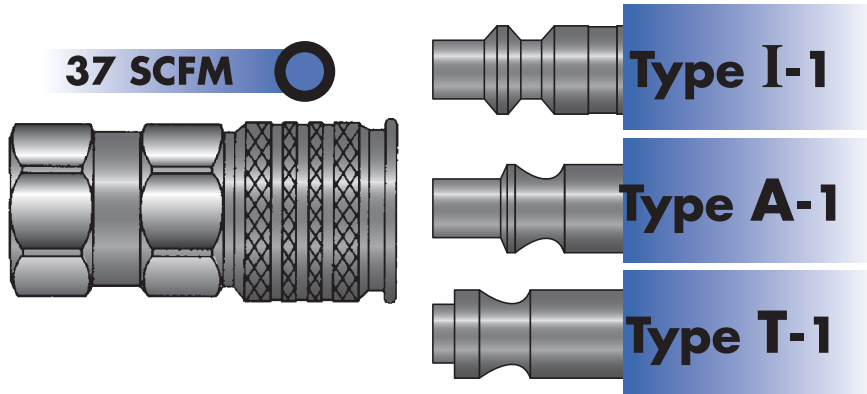

One Way Shut-Off



**AUTOMATIC  
COUPLER  
(BRASS)**

### FEMALE THREAD

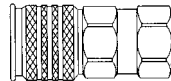

**Part No.**

1/4" (F) NPT

23.2442

### MALE THREAD

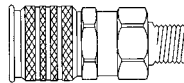

**Part No.**

1/4" (M) NPT

23.2542

### Applications

- Ideal for : Construction work  
Mechanical shops  
Paint and body shops  
Industrial plants  
Vacuum applications

### Features

- Fully compatible with Industrial, Aro and Tru-Flate Types (I-1, A-1 and T-1)
- Fully automatic
- Single handed connection even under pressure

### Specifications

#### Maximum Working Pressure

250 PSI

#### Working Temperature

-40°C to 107°C (-40°F to 225°F)

#### Air Flow

With Aro Type plug : 25 SCFM  
With Tru-Flate Type plug : 34 SCFM  
With Industrial Type plug : 34 SCFM

#### Construction

Body : Brass  
Locking Sleeve : Plated Steel  
Seals : Buna-N  
Locking Balls : Stainless Steel

**THE UNIVERSAL SOLUTION  
TO COMPATIBILITY CONFUSION**

**TYPE A-1  
(ARO)**



**TYPE I-1  
(INDUSTRIAL)**



**TYPE T-1  
(TRU-FLATE)**



**TYPE U-1  
(UNIVERSAL)**

### Applications

- Ideal for : Construction work  
Mechanical shops  
Paint and body shops  
Industrial plants  
Vacuum applications

### Features

- Fully compatible with Industrial, Aro and High-Flow Types (I-1, A-1 and H-1)
- Fully automatic
- Single handed connection even under pressure

### Specifications

#### Maximum Working Pressure

250 PSI

#### Working Temperature

-40°C to 107°C (-40°F to 225°F)

#### Air Flow

With Aro Type plug : 25 SCFM

With High-Flow Type plug : 74 SCFM

With Industrial Type plug : 34 SCFM

#### Construction

Body : Brass

Locking Sleeve : Plated Steel

Seals : Buna-N

Locking Balls : Stainless Steel

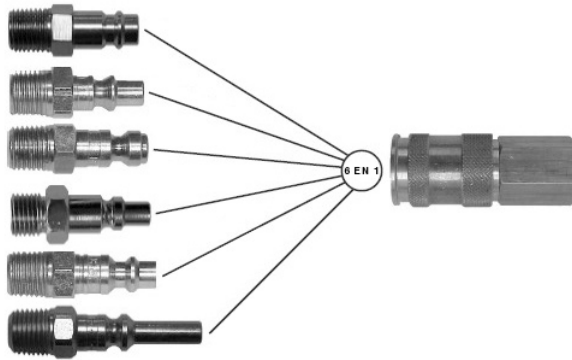

### AUTOMATIC COUPLER (BRASS)

#### FEMALE THREAD

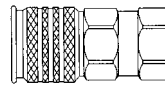

#### Part No.

1/4" (F) NPT

23.2642

3/8" (F) NPT

23.2662

#### MALE THREAD

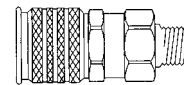

#### Part No.

1/4" (M) NPT

23.2742

3/8" (M) NPT

23.2762

**For any questions or information about  
compressed air you may contact us at  
Tel. : 1-888-730-0501 - Fax : 1-888-730-3522  
or visit our web site at [www.airmax.ca](http://www.airmax.ca)**

## VAL Innovation



One Way Shut-Off

## The Coupler of the year 2000

THE MOST ADVANCED TECHNOLOGY IN THE COUPLER INDUSTRY

COMPATIBLE WITH ALL INDUSTRIAL TYPE COUPLERS ON THE MARKET



### Extremely light

VAL couplers are made of composite materials reinforced with fibreglass



### Non-scratch

Non-scratch - VAL couplers do not scratch surfaces



### Solid and durable



VAL couplers last up to 6 times longer in high-impact applications



### Superior flow



VAL couplers allow 10% more flow than conventional couplers



### The most economical safety coupler on the market

VAL couplers are made to insure up to 200 000 airtight connections



### Safe + Ergonomic

Complies with security norms

- ISO 4414
- DIN EN 983

The shape, weight, size as well as the safety disconnection feature make VAL couplers the essential coupler

### Ideal for body shops

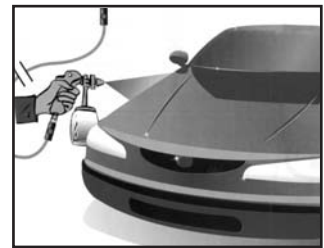

### Ideal for assembly lines



### 2 - way safety disconnection

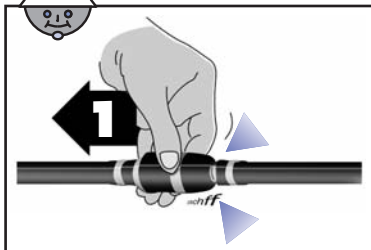

#### 1<sup>ST</sup> STEP

Pulling back on the coupler allows the pressure to escape

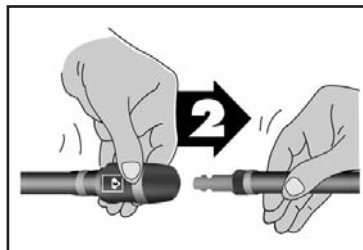

#### 2<sup>ND</sup> STEP

A simple push disconnects the plug

### Prevents dangerous hose whips

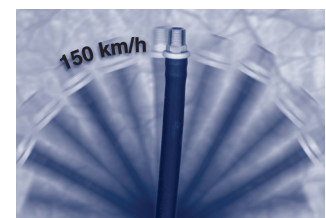

### Easy connection under pressure